

VARIOFACE System Cabling

Front Adapter for the INLINE Automation System

FLKM 14-PA-INLINE/...

1. Short Description

The front adapters are used to connect pre-assembled system cables directly to INLINE and are simply plugged into the relevant INLINE terminals. Two connection options are available:

- Transfer of 2 x 8 channels via two 14-pos. system cables
 - Transfer of 4 x 8 channels via four 14-pos. system cables
- Tailor-made VARIOFACE controller boards complete this system concept.

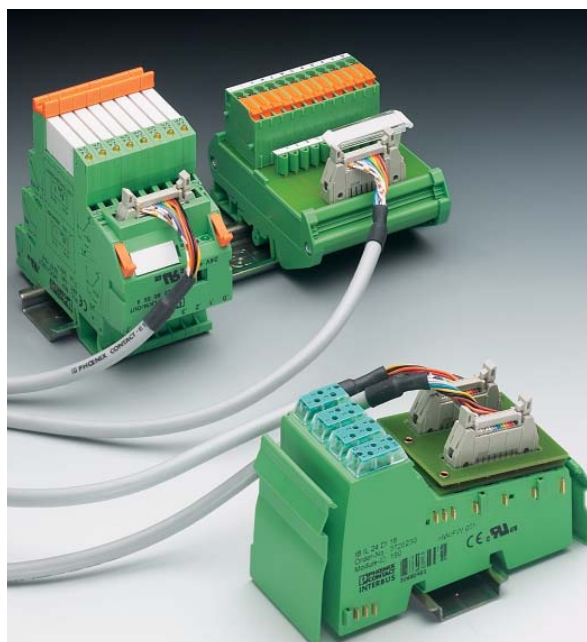

Wiring of a 16-channel INLINE terminal with front adapter, system cables, and VARIOFACE modules.

Pin assignment: 14-pos. flat-ribbon cable male connector

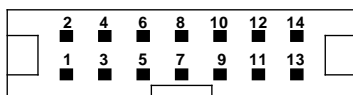

FLKM 14-PA-INLINE/IN16

1 = bit 0	5 = bit 4	9, 11, 13 = "+"
2 = bit 1	6 = bit 5	10, 12, 14 = "-"
3 = bit 2	7 = bit 6	
4 = bit 3	8 = bit 7	

FLKM 14-PA-INLINE/OUT16

1 = bit 0	5 = bit 4	9, 11, 13 = N.C.
2 = bit 1	6 = bit 5	10, 12, 14 = "-"
3 = bit 2	7 = bit 6	
4 = bit 3	8 = bit 7	

FLKM 14-PA-INLINE/32

1 = bit 0	5 = bit 4	9, 11, 13 = N.C.
2 = bit 1	6 = bit 5	10, 12, 14 = N.C.
3 = bit 2	7 = bit 6	
4 = bit 3	8 = bit 7	

Note on the power supply:

The external power supply for the INLINE terminals is provided by power and segment terminals. For INLINE output terminals, a separate supply with U_M/U_S must be provided at the connected VARIOFACE module.

2. Technical Data

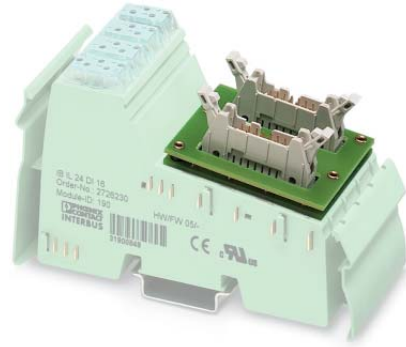

Note:
For pre-assembled cables, please refer to the INTERFACE catalog

FLKM 14-PA-INLINE/... front adapter for INLINE

Flat-ribbon cable male connector according to IEC 603-1/DIN 41 651
Number of poles: 2 x 14 (FLKM 14-PA-INLINE/...16)
4 x 14 (FLKM 14-PA-INLINE/32)

Description	Cable Length [m]
VARIOFACE front adapter for 16-channel INLINE terminals	Input IB IL 24 DI 16 Output IB IL 24 DO 16
VARIOFACE front adapter for 32-channel INLINE terminals	Input IB IL 24 DI 32/HD Output IB IL 24 DO 32/HD

Type	Order No.	Pcs. Pkt.
FLKM 14-PA-INLINE/IN16	23 02 75 1	1
FLKM 14-PA-INLINE/OUT16	23 02 76 4	1
FLKM 14-PA-INLINE/32	23 02 77 7	1

Technical Data

Maximum permissible operating voltage
Maximum permissible current (per branch)
Test voltage (contact/contact)
Ambient operating temperature range
Standards/specifications

60 V AC/DC
1 A
0.5 kV, 50 Hz, 60 s
-25°C to +55°C (-13°F to +131°F)
IEC 60 664/IEC 60 664 A/DIN VDE 0110, DIN VDE 0160 (in parts)

Connection diagram for FLKM 14-PA-INLINE/IN16

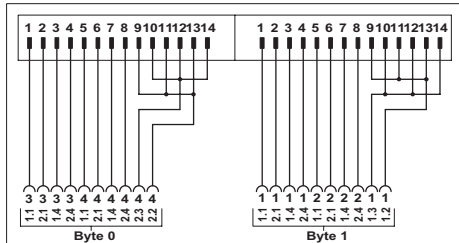

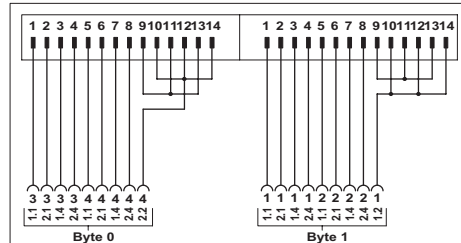

Connection diagram for FLKM 14-PA-INLINE/OUT16

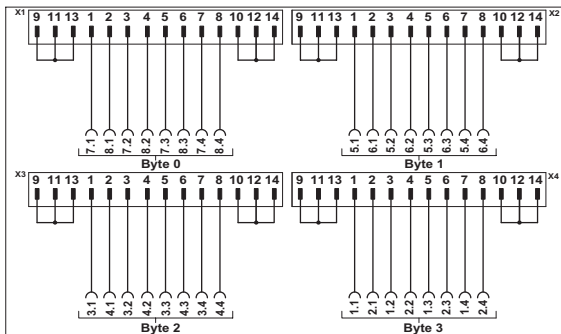

Connection diagram for FLKM 14-PA-INLINE/32



Key:
 14-pos. flat-ribbon cable strip
 Connection to INLINE terminal points
 E.g., 4 = slot 4, 1.1 = terminal point 1.1