



This document is the property of and embodies
 CONFIDENTIAL and PROPRIETARY information of FCI.
 No part of the information shown on this
 document may be used in any way or disclosed
 to others without the written consent of FCI.
 Copyright FCI.

PRODUCT NUMBER
SEE BELOW AND TABLE ON SHEET 2

84817-X YY ZZZ LF
 BASE NUMBER

LEAD FREE (OPTIONAL)
 SPECIAL LOAD PATTERN
 SEE SHEETS 7-9

SIZE, SEE SHEET 2
 PLATING PERFORMANCE
 LEVEL, SEE SHEET 2



DETAIL A
 SCALE 4:1
 SEE NOTE 17

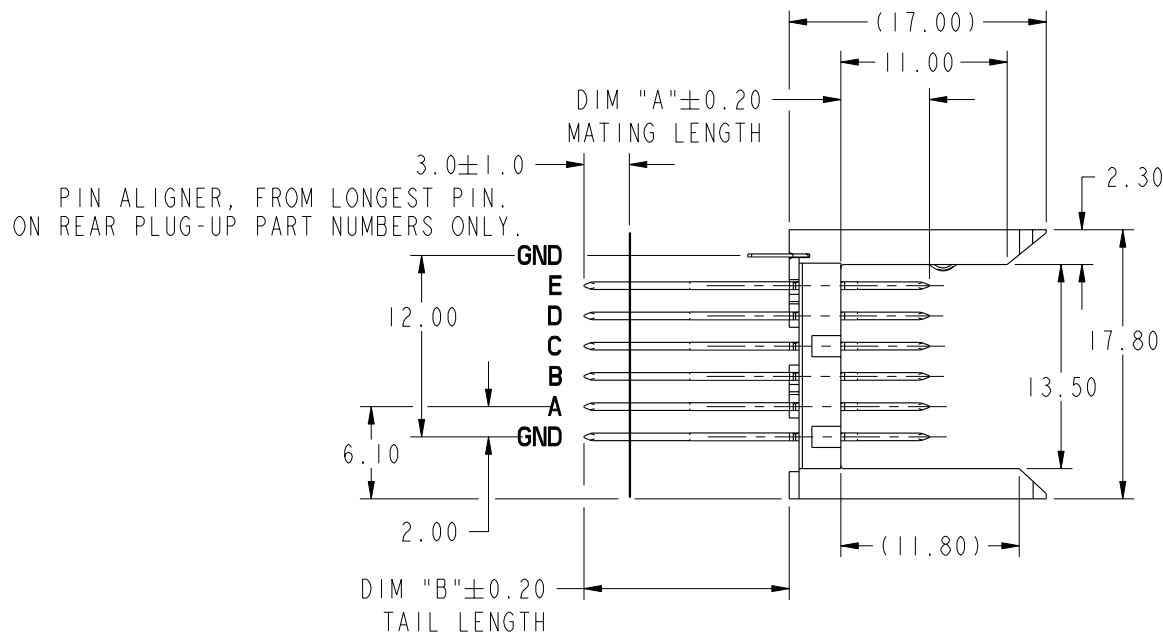
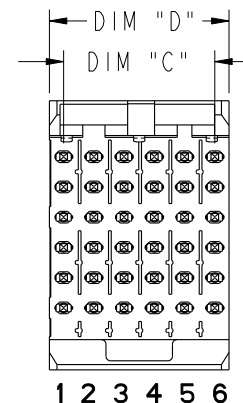
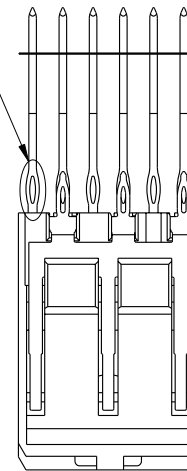

mat'l code SEE NOTE 5				tolerances unless otherwise specified				CUSTOMER	FCI www.fciconnect.com	
ltr	ecn no.	dr	date	linear	0.X ± .1	COPY		title		
AC	V06-0569	DCH	2006-06-12	linear	0.XX ± .05	projection		VERTICAL SIGNAL HDR 5 ROW PRESS-FIT, SPECIAL LOAD, STD.		
AD	V07-0047	HTB	2007-01-19	angles	.XXX ± .020	MM		product family METRAL 1000 code		
AE	V07-0166	DCH	2007-03-01	angles	0° ± 2°	scale		size		
AF	V07-0676	HTB	2007-11-08	dr	K. BELL 2000-03-29	1:1		dwg no		
AG	V08-0009	LP	2008-1-23	engr	M. HAHN 2000-03-29	A		84817		
-	-	-	-	chr	M. HAHN 2000-03-29			213		
AB	V05-0806	VS	2005-09-13	appd	M. HAHN 2000-03-29			sheet		
sheet index		revision sheet	AG 1	AG 2	AG 3	AG 4	AG 5	AG 6	AG 7	1 of 7

cage code 22526

This document is the property of and embodies CONFIDENTIAL and PROPRIETARY information of FCI. No part of the information shown on this document may be used in any way or disclosed to others without the written consent of FCI. Copyright FCI.



PRODUCT NO.	PLATING PERFORMANCE LEVEL	SHROUD TO USE FOR REAR-PLUG-UP APPLICATIONS	LENGTH DIM D	PIN FIELD DIM C	CONNECTOR SIZE	PRODUCT NO.	PLATING PERFORMANCE LEVEL	SHROUD TO USE FOR REAR-PLUG-UP APPLICATIONS	LENGTH DIM D	PIN FIELD DIM C	CONNECTOR SIZE
84817-101ZZZ	TELCORDIA CO	84818-101	11.88	10.00	1 MOD	84817-901ZZZ	TELCORDIA CO	84818-101	11.88	10.00	1 MOD
84817-101ZZZLF		84818-101LF				84817-901ZZZLF		84818-101LF			
84817-102ZZZ		84818-102	23.88	22.00	2 MOD	84817-902ZZZ		84818-102	23.88	22.00	2 MOD
84817-102ZZZLF		84818-102LF				84817-902ZZZLF		84818-102LF			
84817-103ZZZ		84818-103	35.88	34.00	3 MOD	84817-903ZZZ		84818-103	35.88	34.00	3 MOD
84817-103ZZZLF		84818-103LF				84817-903ZZZLF		84818-103LF			
84817-104ZZZ		84818-104	47.88	46.00	4 MOD	84817-904ZZZ		84818-104	47.88	46.00	4 MOD
84817-104ZZZLF		84818-104LF				84817-904ZZZLF		84818-104LF			
84817-301ZZZ	CUSTOMER SPECIAL	84818-301	11.88	10.00	1 MOD						
84817-301ZZZLF		84818-301LF									
84817-302ZZZ		84818-302	23.88	22.00	2 MOD						
84817-302ZZZLF		84818-302LF									
84817-303ZZZ		84818-303	35.88	34.00	3 MOD						
84817-303ZZZLF		84818-303LF									
84817-304ZZZ		84818-304	47.88	46.00	4 MOD						
84817-304ZZZLF		84818-304LF									
84817-501ZZZ	TELCORDIA UE	84818-501	11.88	10.00	1 MOD						
84817-501ZZZLF		84818-501LF									
84817-502ZZZ		84818-502	23.88	22.00	2 MOD						
84817-502ZZZLF		84818-502LF									
84817-503ZZZ		84818-503	35.88	34.00	3 MOD						
84817-503ZZZLF		84818-503LF									
84817-504ZZZ		84818-504	47.88	46.00	4 MOD						
84817-504ZZZLF		84818-504LF									

mat'l code SEE NOTE 5				tolerances unless otherwise specified		CUSTOMER		FCI www.fciconnect.com	
ltr	ecr no.	dr	date	linear	0.X ±0.1		COPY		title VERTICAL SIGNAL HDR 5 ROW PRESS-FIT, SPECIAL LOAD, STD.
AG					0.XX ±0.05		projection		
					.XXX ±.020				
				angles	0° ±2°				product family METRAL 1000 code 213 size dwg no 84817 sheet 2
				dr	K. BELL	2000-03-29	MM		
				enrg	M. HAHN	2000-03-29			
				chr	M. HAHN	2000-03-29	scale 1:1		
				appd	M. HAHN	2000-03-29	A		
sheet index	revision sheet								cage code 22526

RECOMMENDED PCB LAYOUT

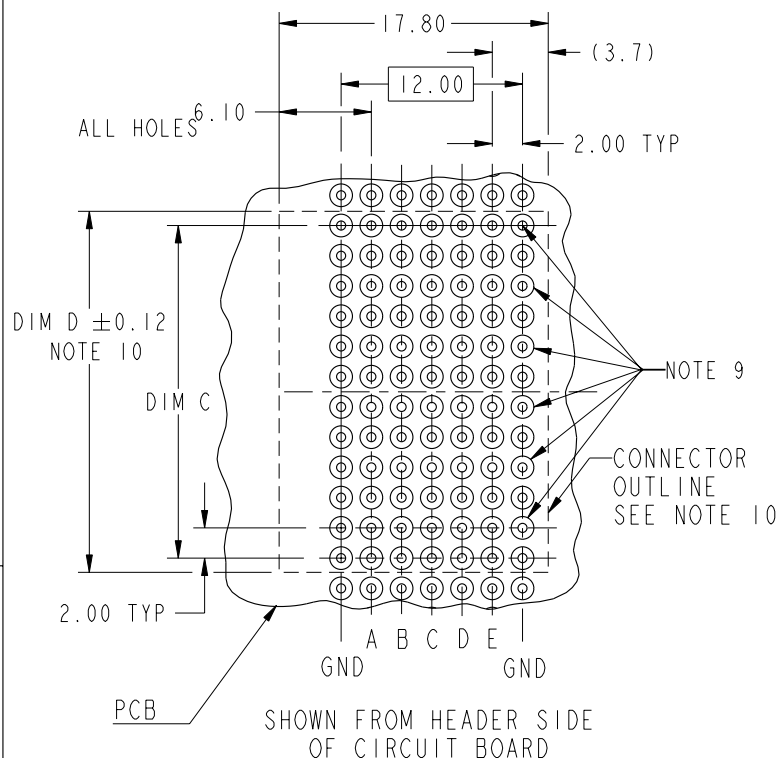

NOTES:

1. SEE APPLICATION SPECIFICATION GS-20-010 FOR INFORMATION ON AVAILABLE TOOLING, CIRCUIT BOARD DESIGN CONSIDERATIONS, REPAIR PROCEDURES AND PRODUCT OFFERINGS.
2. SEE FCI PUBLICATION 950511-028 FOR "ELECTRICAL PERFORMANCE DATA FOR DIFFERENTIAL APPLICATIONS."
3. SEE FCI PUBLICATION 950511-029 FOR "ELECTRICAL PERFORMANCE DATA FOR SINGLE-ENDED APPLICATION."
4. UNLESS OTHERWISE SPECIFIED, ALL DIMENSIONS AND TOLERANCES ARE IN ACCORDANCE WITH ASME Y14.5, 1994
5. HOUSING MATERIAL: LCP, 30% GLASS FILLED, FLAME RETARDANT PER UL 94-V0.
PIN MATERIAL: PHOSPHER BRONZE
GROUND SPRING MATERIAL: PHOSPHER BRONZE
6. PLATING INFORMATION: PLATING ON CONTACT AREA MEETS THE PERFORMANCE LEVELS AS SHOWN IN TABLE ON SHEET 1. PLATING ON "LF" TAILS IS Sn. PLATING ON ALL OTHER TAILS IS SnPb.
7. DIMENSIONAL RESTRICTIONS OF PINS IN HEADERS.
FOR MATING WITH METRAL 1000 RECEPTACLES
DIM A : 5.00mm MIN, 8.00mm MAX FOR ROWS A-E
DIM A : 5.00mm MIN, 5.75mm MAX FOR ROW GND NEXT TO ROW A
DIM C : 5.00mm MIN, 8.00mm MAX FOR ROWS A-E
DIM C : 4.60mm MIN, 6.30mm MAX FOR ROW GND NEXT TO ROW A
FOR MATING WITH METRAL 4000 RECEPTACLES
DIM A : 5.00mm MIN, 6.50mm MAX FOR ROWS A, B, D & E
DIM A : 5.00mm MIN, 8.00mm MAX FOR ROW C
DIM A : 5.00mm MIN, 5.75mm MAX FOR ROW GND NEXT TO ROW A
DIM C : 5.00mm MIN, 7.00mm MAX FOR ROWS A, B, D & E
DIM C : 5.00mm MIN, 8.00mm MAX FOR ROW C
DIM C : 4.60mm MIN, 6.30mm MAX FOR ROW GND NEXT TO ROW A
8. THE MIN PCB THICKNESS FOR REAR PLUG-UP APPLICATIONS IS 2.9mm SINCE THE COMPLAINT SECTIONS OF THE GROUND SPRING OF THE HEADER DIRECTLY OPPOSE THE GROUND SPRING OF THE SHROUD. THE MIN PCB THICKNESS FOR FRONT PLUG-UP ONLY APPLICATIONS IS 1.6mm.
9. THESE HOLES ARE NEEDED FOR REAR PLUG-UP DESIGNS USING A SHROUD AND MAY BE OMITTED FOR FRONT PLUG-UP ONLY DESIGNS.
10. THE "CONNECTOR OUTLINE" IS THE MIN OUTLINE REQUIRED. TO DETERMINE THE OUTLINE NECESSARY TO PERMIT THE VARIOUS TYPES OF REPAIR OPERATIONS, SEE APPLICATION SPECIFICATION GS-20-010.
11. CURRENT RATING : 1 AMP PER PIN
12. TEMPERATURE RANGE : -55°C TO +105°C
13. P/N 84817-X01ZZZ SHOWN ON SHEET 1.
14. THE PRODUCTS WHERE THE PART NUMBERS END IN "LF" MEET EUROPEAN UNION DIRECTIVES AND OTHER COUNTRY REGULATIONS AS DESCRIBED IN GS-22-008. ALL PRODUCTS WILL WITHSTAND EXPOSURE TO 260°C FOR 60 SECONDS IN A CONVECTION INFRA-RED OR VAPOR PHASE REFLOW OVEN.
15. FOR LEAD FREE PART NUMBERS, ADD "LF" SUFFIX. EXAMPLE:84817-XXXXLF.
16. SEE PRODUCT SPEC GS-12-110 FOR PERFORMANCE, TEST, AND SIGNAL INTEGRITY INFORMATION.
17. PIN TYPE IS AT THE MANUFACTURERS OPTION AND CAN BE EITHER BABY-H OR EYE OF THE NEEDLE STYLE

PRESS-FIT HOLES	OPTION 1
HOLE DIAMETER AFTER PLATING	0.65-0.80
DRILLED HOLE	0.81-0.86 (0.85 DRILL)
COPPER PLATING	0.025 MIN
SnPb PLATING	0.005-0.015

SEE PRINT 58315 FOR ADDITIONAL PCB INFORMATION

mat'l code SEE NOTE 5		tolerances unless otherwise specified		CUSTOMER		FCI www.fciconnect.com	
ltr	ecr no.	dr	date	linear	0.X ±.1	COPY	
AG				linear	0.XX ±.05	projection	
				angles	.XXX ±.020		
				dr	0° ±2°		
				enrg	K. BELL 2000-03-29	product family	METRAL 1000
				chr	M. HAHN 2000-03-29	size	dwg no
				appd	M. HAHN 2000-03-29	scale	1:1
sheet index	revision sheet					A	84817
							code
							213
							sheet
							3

This document is the property of and embodies CONFIDENTIAL and PROPRIETARY information of FCI. No part of the information shown on this document may be used in any way or disclosed to others without the written consent of FCI. Copyright FCI.

PIN NO.	DIM A MATING LENGTH	DIM B TAIL LENGTH	PCB THICKNESS RANGE ACCOMMODATED BY PIN'S TAIL LENGTH				
			WHEN MATING TO A 73981 OR 84688 SERIES RECEPTACLE		WHEN MATING TO A 52057 SERIES METRAL 4000 RECEPTACLE		
			ROWS A,B,C,D,E	GROUND ROW	ROWS:A,B,DE	ROW C	GROUND ROW
01*	5.00	4.30	1.60 MIN	1.60 MIN	1.60 MIN	1.60 MIN	1.60 MIN
22		12.20	2.95 - 3.80	2.95 - 4.20	2.95 - 3.80	2.95 - 3.80	2.95 - 4.20
30		12.95	2.95 - 4.55	3.25 - 4.95	2.95 - 4.55	2.95 - 4.55	3.25 - 4.95
05		13.70	2.95 - 5.30	4.00 - 5.70	3.30 - 5.30	2.95 - 5.30	4.00 - 5.70
35		14.45	3.05 - 6.05	4.75 - 6.45	4.05 - 6.05	3.05 - 6.05	4.75 - 6.45
48		15.20	3.80 - 6.80	5.50 - 7.20	4.80 - 6.80	3.80 - 6.80	5.50 - 7.20
40		15.70	4.30 - 7.30	6.00 - 7.70	5.30 - 7.30	4.30 - 7.30	6.00 - 7.70
65		16.40	5.00 - 8.00	6.70 - 8.40	6.00 - 8.00	5.00 - 8.00	6.70 - 8.40
09		17.10	5.70 - 8.70	7.40 - 9.10	6.70 - 8.70	5.70 - 8.70	7.40 - 9.10
02*	5.75	4.30	1.60 MIN	1.60 MIN	1.60 MIN	1.60 MIN	1.60 MIN
44		12.20	2.95 - 3.80	2.95 - 4.20	2.95 - 3.80	2.95 - 3.80	2.95 - 4.20
31		12.95	2.95 - 4.55	3.25 - 4.95	2.95 - 4.55	2.95 - 4.55	3.25 - 4.95
06		13.70	2.95 - 5.30	4.00 - 5.70	3.30 - 5.30	2.95 - 5.30	4.00 - 5.70
36		14.45	3.05 - 6.05	4.75 - 6.45	4.05 - 6.05	3.05 - 6.05	4.75 - 6.45
49		15.20	3.80 - 6.80	5.50 - 7.20	4.80 - 6.80	3.80 - 6.80	5.50 - 7.20
25		15.70	4.30 - 7.30	6.00 - 7.70	5.30 - 7.30	4.30 - 7.30	6.00 - 7.70
66		16.40	5.00 - 8.00	6.70 - 8.40	6.00 - 8.00	5.00 - 8.00	6.70 - 8.40
10		17.10	5.70 - 8.70	7.40 - 9.10	6.70 - 8.70	5.70 - 8.70	7.40 - 9.10
03*	6.50	4.30	1.60 MIN	1.60 MIN	1.60 MIN	1.60 MIN	1.60 MIN
45		12.20	2.95 - 3.80	2.95 - 4.20	2.95 - 3.80	2.95 - 3.80	2.95 - 4.20
32		12.95	2.95 - 4.55	3.25 - 4.95	2.95 - 4.55	2.95 - 4.55	3.25 - 4.95
07		13.70	2.95 - 5.30	4.00 - 5.70	3.30 - 5.30	2.95 - 5.30	4.00 - 5.70
37		14.45	3.05 - 6.05	4.75 - 6.45	4.05 - 6.05	3.05 - 6.05	4.75 - 6.45
50		15.20	3.80 - 6.80	5.50 - 7.20	4.80 - 6.80	3.80 - 6.80	5.50 - 7.20
41		15.70	4.30 - 7.30	6.00 - 7.70	5.30 - 7.30	4.30 - 7.30	6.00 - 7.70
24		16.40	5.00 - 8.00	6.70 - 8.40	6.00 - 8.00	5.00 - 8.00	6.70 - 8.40
11		17.10	5.70 - 8.70	7.40 - 9.10	6.70 - 8.70	5.70 - 8.70	7.40 - 9.10



This document is the property of and embodies CONFIDENTIAL and PROPRIETARY information of FCI. No part of the information shown on this document may be used in any way or disclosed to others without the written consent of FCI. Copyright FCI.

mat'l code		SEE NOTE 5		tolerances unless otherwise specified		CUSTOMER		FCI www.fciconnect.com	
ltr	ecn no.	dr	date	linear	0.X ± .1		COPY		title VERTICAL SIGNAL HDR 5 ROW PRESS-FIT, SPECIAL LOAD, STD.
AG					0.XX ± .05		projection		
				angles	.XXX ± .020		MM		product family METRAL 1000 code size dwg no 213 A 84817 sheet 4
					0° ± 2°		scale		
				dr	K. BELL	2000-03-29	1:1		
				engr	M. HAHN	2000-03-29			
				chr	M. HAHN	2000-03-29			
				appd	M. HAHN	2000-03-29			
sheet index	revision sheet								

PIN NO.	DIM A MATING LENGTH	DIM B TAIL LENGTH	PCB THICKNESS RANGE ACCOMMODATED BY PIN LENGTH				
			WHEN MATING TO A 73981 OR 84688 SERIES RECEPTACLE		WHEN MATING TO A 52057 SERIES METRAL 4000 RECEPTACLE		
			ROWS A,B,C,D,E	GROUND ROW	ROWS:A,B,DE	ROW C	GROUND ROW
04*	7.25	4.30	1.60 MIN	1.60 MIN	1.60 MIN	1.60 MIN	1.60 MIN
46		12.20	2.95 - 3.80	2.95 - 4.20	2.95 - 3.80	2.95 - 3.80	2.95 - 4.20
33		12.95	2.95 - 4.55	3.25 - 4.95	2.95 - 4.55	2.95 - 4.55	3.25 - 4.95
08		13.70	2.95 - 5.30	4.00 - 5.70	3.30 - 5.30	2.95 - 5.30	4.00 - 5.70
38		14.45	3.05 - 6.05	4.75 - 6.45	4.05 - 6.05	3.05 - 6.05	4.75 - 6.45
51		15.20	3.80 - 6.80	5.50 - 7.20	4.80 - 6.80	3.80 - 6.80	5.50 - 7.20
42		15.70	4.30 - 7.30	6.00 - 7.70	5.30 - 7.30	4.30 - 7.30	6.00 - 7.70
67		16.40	5.00 - 8.00	6.70 - 8.40	6.00 - 8.00	5.00 - 8.00	6.70 - 8.40
12		17.10	5.70 - 8.70	7.40 - 9.10	6.70 - 8.70	5.70 - 8.70	7.40 - 9.10
19*	8.00	4.30	1.60 MIN	1.60 MIN	1.60 MIN	1.60 MIN	1.60 MIN
47		12.20	2.95 - 3.80	2.95 - 4.20	2.95 - 3.80	2.95 - 3.80	2.95 - 4.20
34		12.95	2.95 - 4.55	3.25 - 4.95	2.95 - 4.55	2.95 - 4.55	3.25 - 4.95
20		13.70	2.95 - 5.30	4.00 - 5.70	3.30 - 5.30	2.95 - 5.30	4.00 - 5.70
39		14.45	3.05 - 6.05	4.75 - 6.45	4.05 - 6.05	3.05 - 6.05	4.75 - 6.45
52		15.20	3.80 - 6.80	5.50 - 7.20	4.80 - 6.80	3.80 - 6.80	5.50 - 7.20
43		15.70	4.30 - 7.30	6.00 - 7.70	5.30 - 7.30	4.30 - 7.30	6.00 - 7.70
68		16.40	5.00 - 8.00	6.70 - 8.40	6.00 - 8.00	5.00 - 8.00	6.70 - 8.40
21		17.10	5.70 - 8.70	7.40 - 9.10	6.70 - 8.70	5.70 - 8.70	7.40 - 9.10

* STUB PINS - NO REAR PLUG-UP
 ** THE GREATEST RANGE OCCURS WHEN THE B DIMENSION OF PIN 'GND' IS ONE SIZE SHORTER THEN THE OTHER PINS.



This document is the property of and embodies CONFIDENTIAL and PROPRIETARY information of FCI. No part of the information shown on this document may be used in any way or disclosed to others without the written consent of FCI. Copyright FCI.

mat'l code SEE NOTE 5				tolerances unless otherwise specified		CUSTOMER		www.fciconnect.com	
ltr	ecn no.	dr	date	linear	0.X ± .1		COPY		title VERTICAL SIGNAL HDR 5 ROW PRESS-FIT, SPECIAL LOAD, STD.
AG					0.XX ± .05		projection		
				angles	.XXX ± .020				product family METRAL 1000 code size dwg no 213 sheet 5
					0° ± 2°				
				dr	K. BELL	2000-03-29	scale		A 84817
				engr	M. HAHN	2000-03-29	1:1		
				chr	M. HAHN	2000-03-29			
				appd	M. HAHN	2000-03-29			
sheet index	revision sheet								

SPECIAL LOAD PATTERNS		
PRODUCT #	ROW	PIN CODES
84817-XY001 SEE NOTE 15 LEAD FREE OPTION	E	01
	D	
	C	
	B	
	A	
GND		
84817-XY002 *RPU SEE NOTE 15 LEAD FREE OPTION	E	22
	D	
	C	
	B	
	A	
GND		
84817-XY011 SEE NOTE 15 LEAD FREE OPTION	E	02
	D	
	C	
	B	
	A	
GND	01	
84817-XY021 SEE NOTE 15 LEAD FREE OPTION	E	02
	D	
	C	
	B	
	A	
GND		
84817-XY022 SEE NOTE 15 LEAD FREE OPTION	E	02
	D	
	C	
	B	
	A	
GND		
84817-XY023 SEE NOTE 15 LEAD FREE OPTION	E	02
	D	02
	C	04
	B	02
	A	
GND		
84817-XY024 *RPU SEE NOTE 15 LEAD FREE OPTION	E	06
	D	08
	C	06
	B	
	A	
GND		
84817-XY025 *RPU SEE NOTE 15 LEAD FREE OPTION	E	06
	D	
	C	
	B	
	A	
GND	01	

PCB THICKNESS
RANGE FOR REAR
PLUG UP
APPLICATIONS:
2.95 TO 3.80mm

PCB THICKNESS
RANGE FOR REAR
PLUG UP
APPLICATIONS:
4.00 TO 5.30mm

PCB THICKNESS
RANGE FOR REAR
PLUG UP
APPLICATIONS:
*2.30-3.30 TO 5.30mm



SPECIAL LOAD PATTERNS		
PRODUCT #	ROW	PIN CODES
84817-XY026 *RPU SEE NOTE 15 LEAD FREE OPTION	E	22
	D	
	C	
	B	
	A	
GND	01	
84817-XY027 *RPU SEE NOTE 15 LEAD FREE OPTION	E	44
	D	
	C	
	B	
	A	
GND		
84817-XY028 SEE NOTE 15 LEAD FREE OPTION	E	01
	D	03
	C	01
	B	
	A	
GND		
84817-XY029 SEE NOTE 15 LEAD FREE OPTION	E	02
	D	03
	C	02
	B	
	A	
GND	01	
84817-XY030 *RPU SEE NOTE 15 LEAD FREE OPTION	E	06
	D	07
	C	06
	B	
	A	
GND	01	
84817-XY031 *RPU SEE NOTE 15 LEAD FREE OPTION	E	25
	D	02
	C	25
	B	
	A	
GND	02	

PCB THICKNESS
RANGE FOR REAR
PLUG UP
APPLICATIONS:
2.95 TO 3.80mm

PCB THICKNESS
RANGE FOR REAR
PLUG UP
APPLICATIONS:
2.95 TO 3.80mm

PCB THICKNESS
RANGE FOR REAR
PLUG UP
APPLICATIONS:
2.95 TO 3.80mm

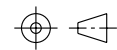
PCB THICKNESS
RANGE FOR REAR
PLUG UP
APPLICATIONS:
2.95 TO 3.80mm

mat'l code SEE NOTE 5		tolerances unless otherwise specified		CUSTOMER		 www.fciconnect.com	
ltr	ecn no.	dr	date	linear	0.X ± .1	COPY	
AG				linear	0.XX ± .05	projection	 title VERTICAL SIGNAL HDR 5 ROW PRESS-FIT, SPECIAL LOAD, STD.
				angles	.XXX ± .020	 product family METRAL 1000 code	
				dr	0° ± 2°		
				engr	K. BELL 2000-03-29	MM	dwg no
				chr	M. HAHN 2000-03-29	← MM →	213
				appd	M. HAHN 2000-03-29	scale	sheet
						1:1	6
sheet	revision						
index	sheet						



This document is the property of and embodies
 CONFIDENTIAL and PROPRIETARY information of FCj.
 No part of the information shown on this
 document may be used in any way or disclosed
 to others without the written consent of FCj.
 Copyright FCj.

SPECIAL LOAD PATTERNS

PRODUCT #	ROW	PIN CODES
84817-XY032 SEE NOTE 15 LEAD FREE OPTION	E	22
	D	
	C	45
	B	
	A	22
84817-XY033 *RPU SEE NOTE 15 LEAD FREE OPTION	E	06
	D	
	C	
	B	
	A	30
84817-XY034 SEE NOTE 15 LEAD FREE OPTION	E	03
	D	
	C	
	B	
	A	02
84817-XY035 SEE NOTE 15 LEAD FREE OPTION	E	01
	D	
	C	
	B	
	A	-
84817-XY036 *RPU SEE NOTE 15 LEAD FREE OPTION	E	22
	D	
	C	
	B	
	A	01
84817-XY037 SEE NOTE 15 LEAD FREE OPTION	E	01
	D	
	C	
	B	
	A	02
84817-XY038 *RPU SEE NOTE 15 LEAD FREE OPTION	E	49
	D	
	C	
	B	
	A	
84817-XY039 *RPU SEE NOTE 15 LEAD FREE OPTION	E	36
	D	
	C	
	B	
	A	
	GND	06

PCB THICKNESS
RANGE FOR REAR
PLUG UP
APPLICATIONS:
2.95 TO 3.80mm

PCB THICKNESS
RANGE FOR REAR
PLUG UP
APPLICATIONS:
4.80 TO 6.80mm

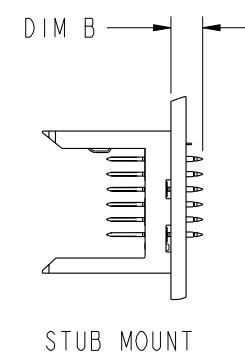
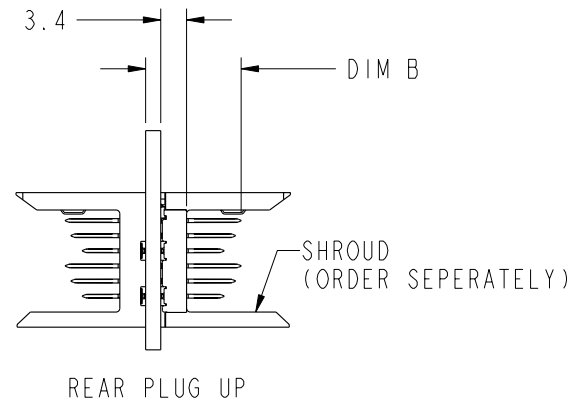

This document is the property of and embodies
 CONFIDENTIAL and PROPRIETARY information of FCI.
 No part of the information shown on this
 document may be used in any way or disclosed
 to others without the written consent of FCI.
 Copyright FCI.

mat'l code SEE NOTE 5				tolerances unless otherwise specified		CUSTOMER		FCI www.fciconnect.com		
ltr	ecr no.	dr	date	linear	0.X ± .1	COPY		projection	title VERTICAL SIGNAL HDR 5 ROW PRESS-FIT, SPECIAL LOAD, STD.	
AG					0.XX ± .05	MM				product family METRAL 1000 code 213
					angles	.XXX ± .020	size			
				dr	0° ± 2°	A		sheet 7		
				engr	K. BELL 2000-03-29	scale 1:1				
				chr	M. HAHN 2000-03-29	cage code 22526				
				appd	M. HAHN 2000-03-29	4				
sheet index	revision sheet									