

Surface Mount 1575.42MHz SAW Filter

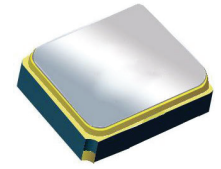

2.0 x 1.6 x 0.9 mm

AFS20A53-1575.42-T3

Moisture Sensitivity Level (MSL) – This product is Hermetically Sealed and not Moisture Sensitive - MSL = N/A: Not Applicable



**RoHS
Compliant**

FEATURES:

- 2.0 x 1.6 x 0.9 mm low profile SMT package
- Low Insertion loss
- Excellent selectivity with high out-of-band rejection

APPLICATIONS:

- Wireless Communication
- Remote Control
- Cellular Phones

ELECTRICAL SPECIFICATIONS:

Maximum Ratings

Item	Value
Input Power Level	+20 dBm max.
DC Permissive Voltage	3.0V DC max.
Operating Temperature Range	-55°C to + 105°C
Storage Temperature Range	-55°C to + 105°C

Parameters	Minimum	Typical	Maximum	Units	Notes
Center Frequency (f_c)		1575.42		MHz	
Insertion Loss (IL)		2.1	3.0	dB	1565.42 ~ 1585.42MHz
Effective Bandwidth	20	53		MHz	
Amplitude Ripple		1.3	2.0	dB	1565.42 ~ 1585.42MHz
Worst-Case Input / Output Return Loss	8	11		dB	1565.42 ~ 1585.42MHz
Group Delay		4	26		1565.42 ~ 1585.42MHz
Stop-band Attenuation (Referenced to 0.0 dB)	15	19		dB	300 ~ 1500MHz
	15	21			1650MHz ~ 1900MHz
	15	21			1900MHz ~ 3000MHz
Source Impedance (Z_S)		50		Ω	See note # 1
Load Impedance (Z_L)		50		Ω	See note # 1

Note #1: No matching network required for operation into 50 Ω 's

TEST CIRCUIT:

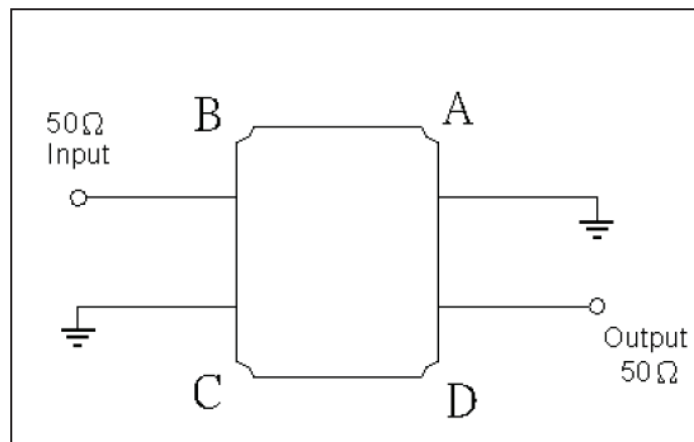

Surface Mount 1575.42MHz SAW Filter

AFS20A53-1575.42-T3

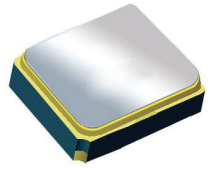

2.0 x 1.6 x 0.9 mm

OUTLINE DIMENSIONS:

#B:	Input
#D:	Output
#A,C:	Ground

* All Dimensions are in mm

Recommended Land Pattern:

*All Dimensions are in mm

FREQUENCY CHARACTERISTICS:

Filter Frequency Response (Narrowband)

1 1.565420000 GHz -2.2121 dB
 >2 1.585420000 GHz -2.9853 dB

Center 1.57542 GHz IFBW 100 kHz Span 100 MHz

Filter Frequency Response (Wideband)

1 1.500000000 GHz -30.979 dB
 2 1.650000000 GHz -27.219 dB
 >3 1.900000000 GHz -21.888 dB

Start 300 kHz IFBW 100 kHz Stop 3 GHz

Detail S-parameter information (.s2p file) available upon request

Surface Mount 1575.42MHz SAW Filter

AFS20A53-1575.42-T3



RoHS
Compliant

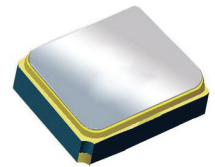

2.0 x 1.6 x 0.9 mm

REFLOW PROFILE:

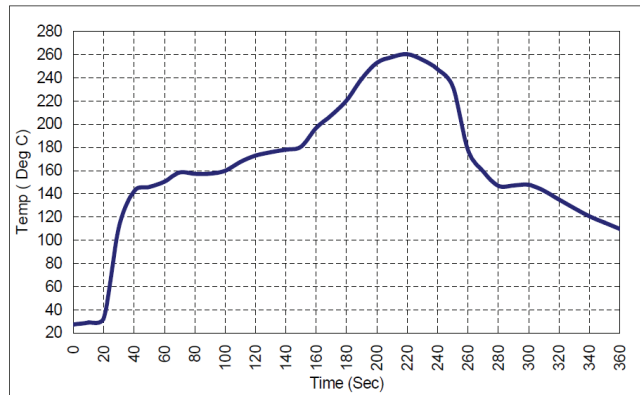

PACKAGING: 3000 Units/Reel “-T2” parts (2k/reel) are no longer available effective 01/01/2013

Reel Count : 7" = 3k units

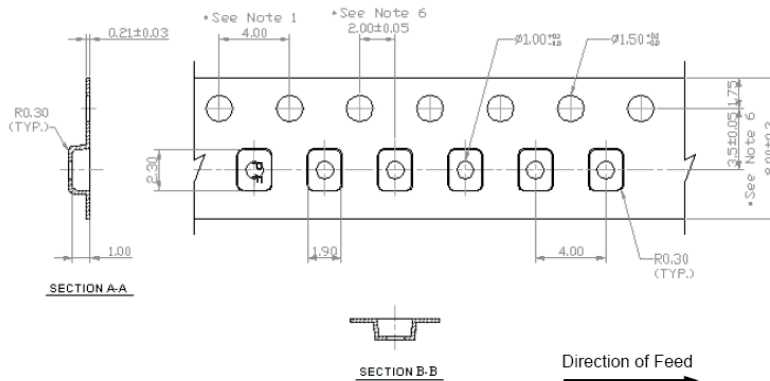

Dimensions: mm

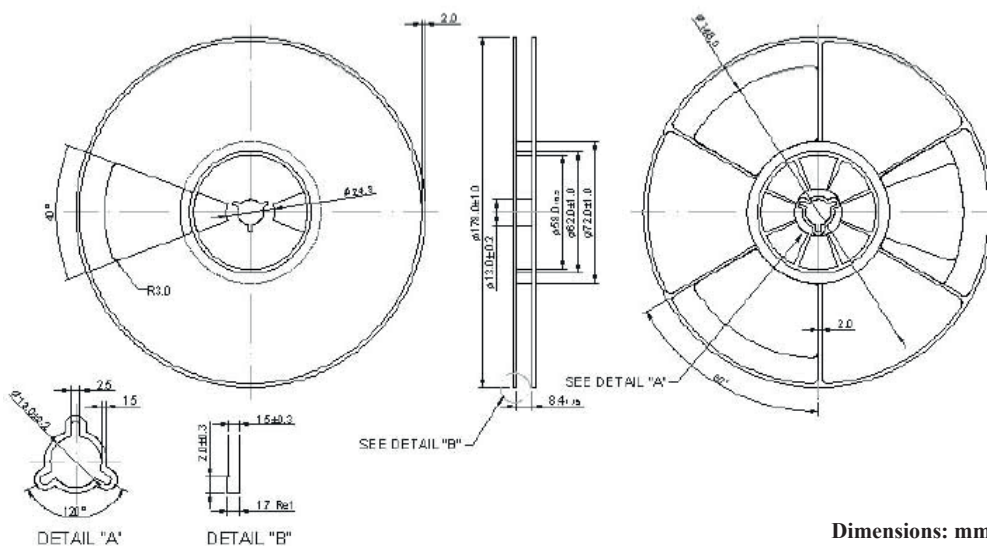

Dimensions: mm

ATTENTION: Abracon Corporation's products are COTS – Commercial-Off-The-Shelf products; suitable for Commercial, Industrial and, where designated, Automotive Applications. Abracon's products are not specifically designed for Military, Aviation, Aerospace, Life-dependant Medical applications or any application requiring high reliability where component failure could result in loss of life and/or property. For applications requiring high reliability and/or presenting an extreme operating environment, written consent and authorization from Abracon Corporation is required. Please contact Abracon Corporation for more information.

ABRACON IS
ISO 9001:2008
CERTIFIED



Visit www.abracon.com for Terms & Conditions of Sale
30332 Esperanza, Rancho Santa Margarita, California 92688
tel 949-546-8000 | fax 949-546-8001 | www.abracon.com

Revised: 04.16.13